



Paulmann

Safety Instructions

1, 2, 3, 4, 5, 6, 7, 8, 11, 12, 15, 16, 17, 18, 19, 20, 21, 22, 24, 26, 33, 34



Info

www.paulmann.com

Paulmann Licht GmbH
Quezinger Feld 2
31832 Springe
Germany

www.paulmann.com

Art.-Nr.:
500.75

(+MA 326) PLD 08/17

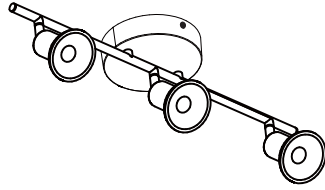

Incl.

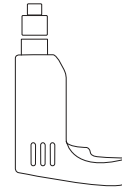
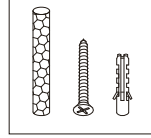

∅ 6mm



A

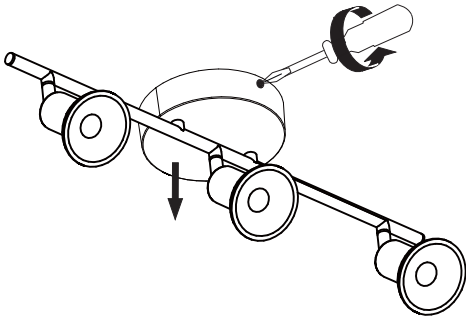

B

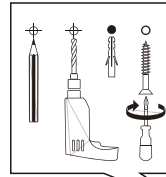

Safety Instructions
Nr. 4, 5, 6, 7

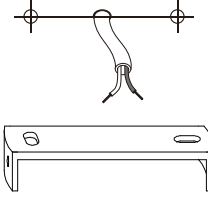

C

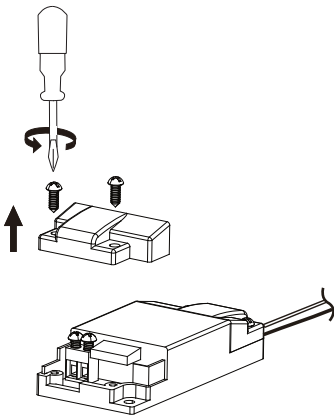

D



Safety Instructions
Nr. 4, 5, 6

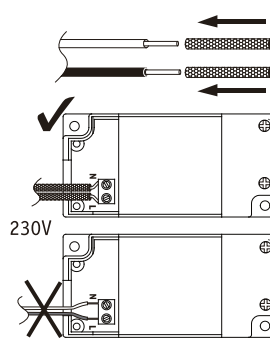
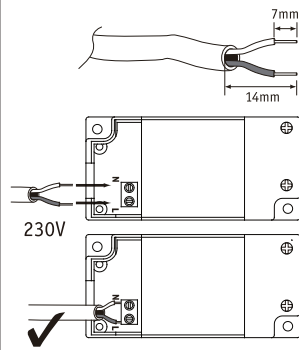

E



Safety Instructions
Nr. 4, 5, 6

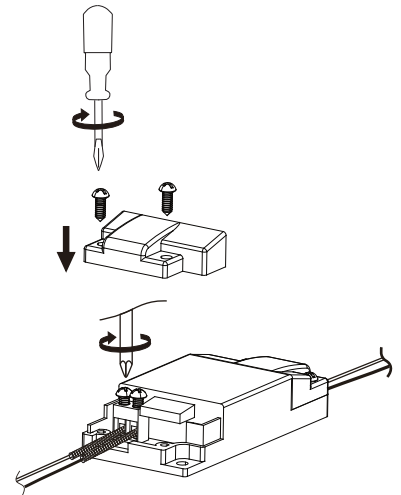

F

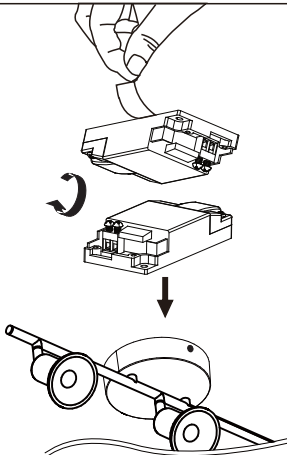

G

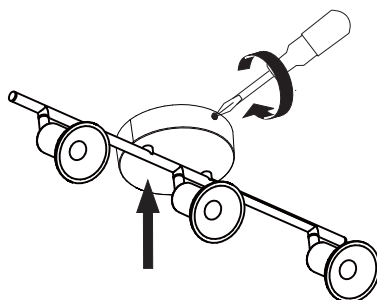

H

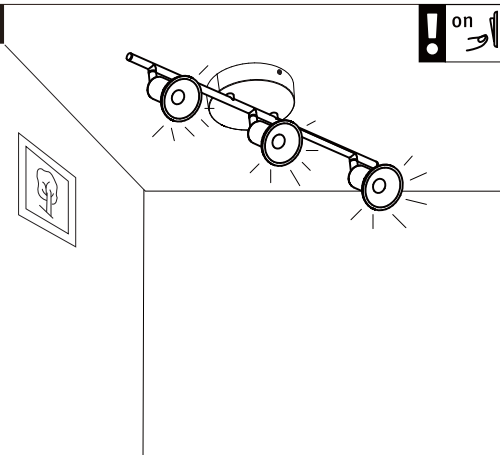

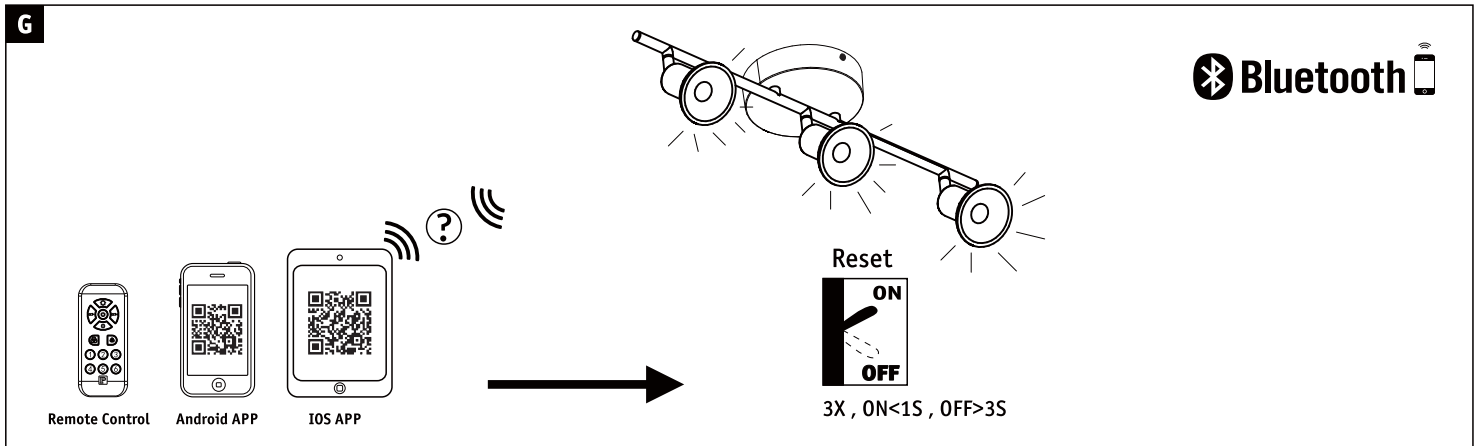
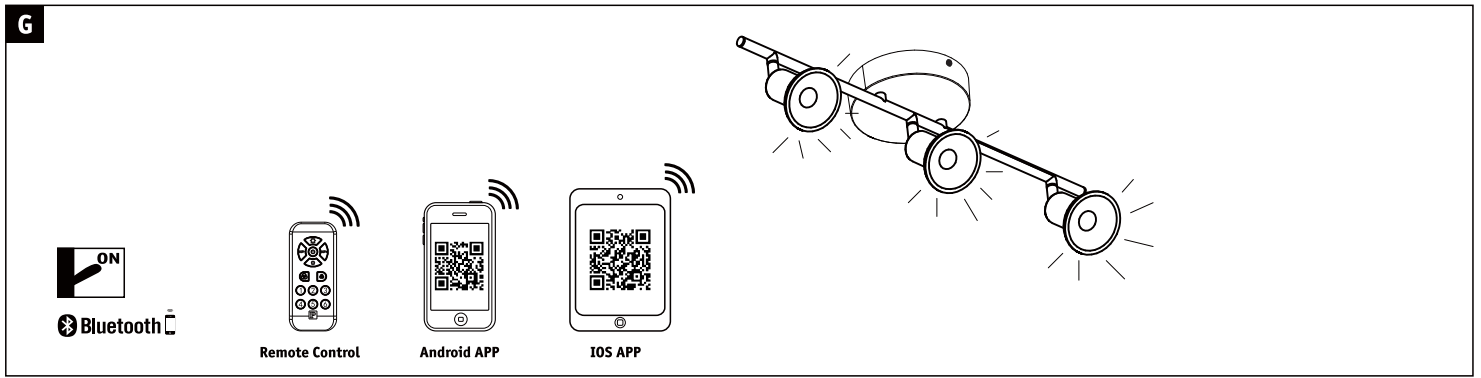

I

Paulmann Home

IOS APP

Android APP

Not incl. Smart Device

- iPad
- iPhone 4S Higher
- Android 4.4 Higher
- Bluetooth 4.0 Higher

Not incl. Remote Control

Paulmann Art.-Nr.500.01

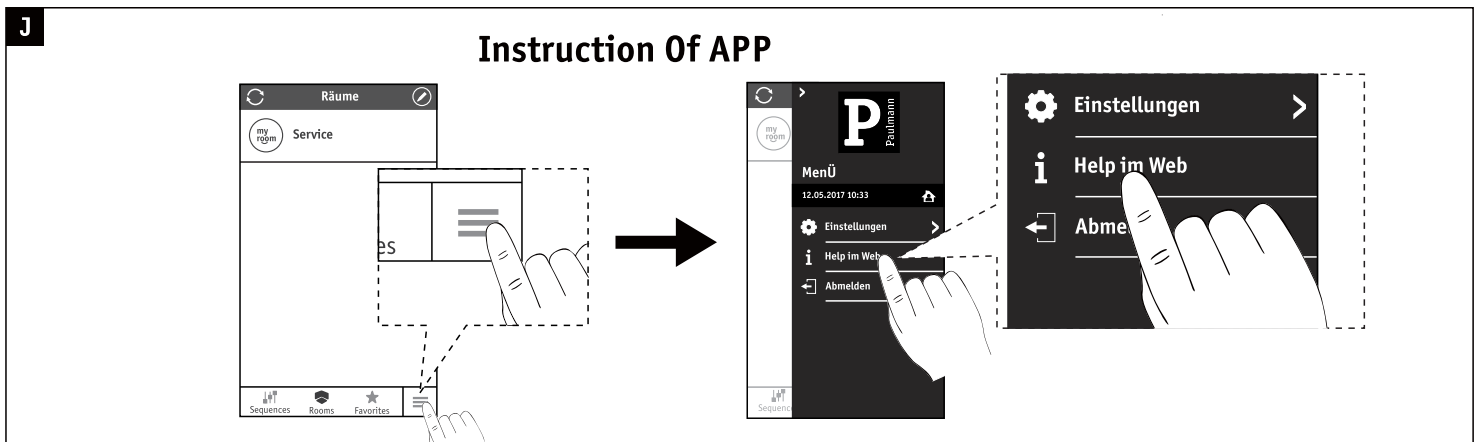

Hiermit erklärt Paulmann Licht, dass der Funkanlagentyp Art.-Nr:500.75 Richtlinie 2014/53/EU entspricht. Der vollständige Text der EU-Konformitätserklärung ist unter der folgenden Internetadresse verfügbar: www.paulmann.de

Zugelassen für den Betrieb in allen Ländern der EU / Approved for operating in all European countries

CE: Konform mit / in accordance with / conformément a 2014/30/EU, 2014/53/EU <http://www.paulmann.com/de/de/b2b-haendler-log-in.html>

2,4 GHz – 2,4835 GHz



Doesn't apply for the geographical area within a radius of 20km from the centre on "Ny Alesund"